



■ Features

- Charger for lithium batteries (Li-ion, LiFePO4 and lithium manganese) and Lead-Acid batteries
- Built- in 4 stage charging curve (For Lithium batteries) and 4 stage charging curve (For Lead-Acid batteries)
- Universal AC input / Full range (90-264V~)
- Built- in active PFC function
- Protection: Short circuit / Over voltage / Over temperature / Battery over voltage / Battery reverse polarity protection
- 2 years warranty

■ Applications

- Radio system backup solution
- Electric scooter charger
- Surveillance system
- Electric motorcycle \ Electric sweeper

■ Description

G1200 is a single output 1200W AC/DC desktop type charger with 4 and 3 stage charging curve. In addition to the embedded pre-defined charging curves, the default curve is programmable and thus able to accommodate different types of batteries, such as Lead-acid batteries (gel, flooded and AGM) and Lithium batteries (Li-ion, LiFePO4 and Lithium manganese). G1200 can be set different charging voltage value, charging current value and charging end current value through USB, according to customer's own requirements. The LCD screen of G1200 can display the voltage, current, capacity, and preset voltage and current.

■ Mode Encoding

G1200-XXXYYY



SPECIFICATION(Li-Fe battery charger)

| MODEL | G1200-288360 | G1200-360300 | G1200-432280 | G1200-576200 | G1200-720160 | |
|------------------------|---|---|-------------------|--------------|-------------------|------------|
| OUTPUT | Charge voltage | 28.8V±1% | 36.0V±1% | 43.2V±1% | 57.6V±1% | 72.0V±1% |
| | Charge voltage range | 20.0-28.8V | 25.0-36.0V | 30.0-43.2V | 40.0-57.6V | 50.0-72.0V |
| | Charge current | 36.0A±10% | 30.0A±10% | 28.0A±10% | 20.0A±10% | 16.0A±10% |
| | Pre-charge current | 7.2A±10% | 6.0A±10% | 5.6A±10% | 4.0A±10% | 3.2A±10% |
| | Charge-end current | ≤3.6A ±10% | ≤3.0A ±10% | ≤2.8A ±10% | ≤2.0A ±10% | ≤1.6A ±10% |
| | Rated power | 1036.8W | 1080W | 1209.6W | 1152W | 1152W |
| | Recommended battery capacity Note.3 | 60 - 200Ah | 40 - 150Ah | 30 - 100Ah | 20 - 80Ah | 15 - 60Ah |
| | Leakage current from battery (Typ.) | ≤1mA | | | | |
| Charge indicator | LCD display | Display voltage,current,capacity | | | | |
| Communication function | USB / CAN / 485 | The battery type (Lead acid, Lithium battery,LiFePO4 battery), charging voltage and charging current can be set by USB interface, Communication with external devices via CAN or RS485. | | | | |
| INPUT | Rated input voltage | 100 - 240VAC 50 / 60Hz | | | | |
| | Input voltage range Note.4 | 90 - 264VAC | | | | |
| | Power factor (Typ.) | PF>0.96 @full load | | | | |
| | Input current (Typ.) | 13A@100VAC | | | | |
| | Inrush current (Typ.) | Cold start 75A @230VAC | | | | |
| | Standby input power | < 4W | | | | |
| | Efficiency (Typ.) | 92% | 92% | 92% | 92% | 92% |
| PROTECTION | Short circuit Note.5 | Protection type : Shut down output | | | | |
| | Over voltage | >3.7V*N | | | | |
| | Reverse polarity | By internal relay | | | | |
| | Over temperature | Shut down output, recovers automatically after temperature goes down | | | | |
| ENVIRONMENT | Working temperature | -10 - +40°C (Refer to " Derating Curve") | | | | |
| | Working humidity | 0 - 90% RH | | | | |
| | Storage temperature, humidity | -40 - +70°C, 0 - 95% RH | | | | |
| | Cooling | Fan convection | | | | |
| | Vibration resistance | 10 - 50Hz, 2G 10min. 1cycle, 60min. each along X, Y, Z axes | | | | |
| Safety & EMC (Note 6) | Max. temperature rise | < 40°C on casing | | | | |
| | Hi-Pot Insulation | i/p to o/p: 3000V (1 min) | | | | |
| | Safety standards | IEC60950.1 | | | | |
| | EMC Emission | Parameter | standard | | Test Level I Note | |
| | | Conducted | EN55032 FCCPART15 | | Class B | |
| | | Radiated | EN55032 FCCPART15 | | Class B | |
| | | Harmonic Current | EN61000-3-2 | | | |
| Voltage Flicker | EN61000-3-3 | | | | | |
| EMC IMMUNITY | EN61000-4-2, EN61000-4-3, EN61000-4-4, EN61000-4-5, EN61000-4-6, EN61000-4-8, EN61000-4-11 | | | | | |
| OTHERS | MTBF | 30000H | | | | |
| | Dimension | 265*134*60mm (L*W*H) | | | | |
| | Weight | 2300g | | | | |
| NOTE | <p>1. Modification for charger specification may be required for different battery specification. Please contact battery vendor and Green digital power for details.</p> <p>2. All parameters NOT specially mentioned are measured at 230VAC input, rated load and 25°C of ambient temperature.</p> <p>3. This is Green suggested range. Please consult your battery manufacturer for their suggestions about maximum charging current limitation.</p> <p>4. Derating may be needed under low input voltages. Please check the derating curve for more details.</p> <p>5. This protection mechanism is specified for the case the short circuit occurs after the charger is turned on.</p> <p>6. The battery charger is considered as an independent unit, but the final equipment still need to re-confirm that the whole system complies with the EMC directives. For guidance on how to perform these EMC tests, please refer to "EM I testing of component power supplies."</p> | | | | | |

■ **Block Diagram**

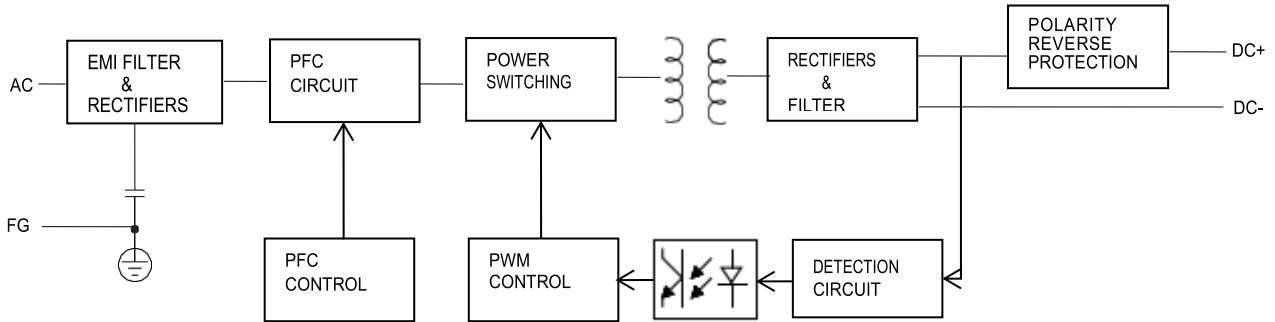

■ **Derating Curve**

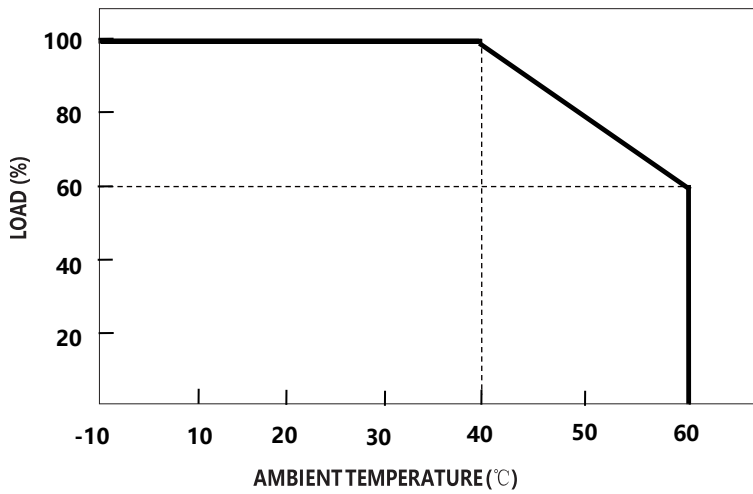

■ **static Characteristics**

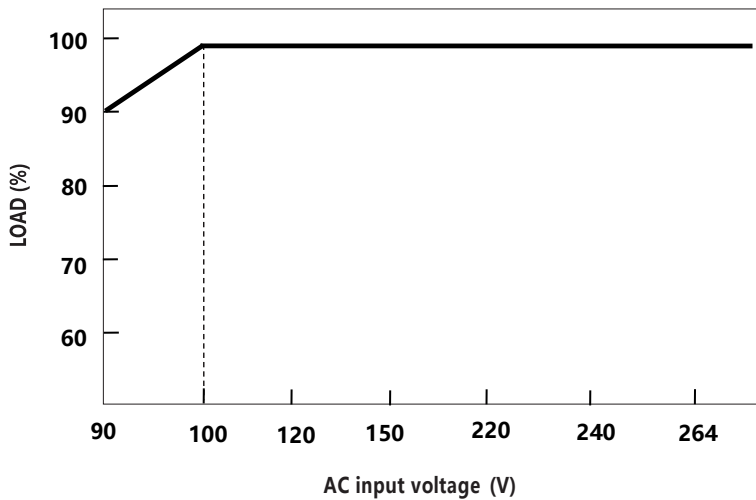

■ **Function Manual**

1. Charging Curve

◎ 4 stage charging curve(Li-ion battery charger)

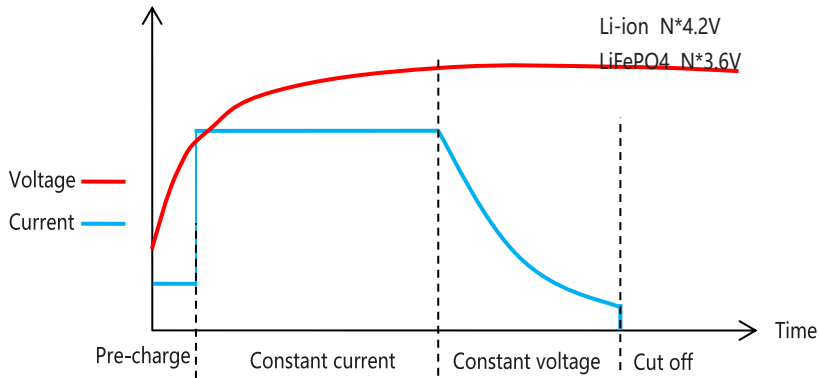

◎ 3 stage charging curve(Lead-Acid battery charger)

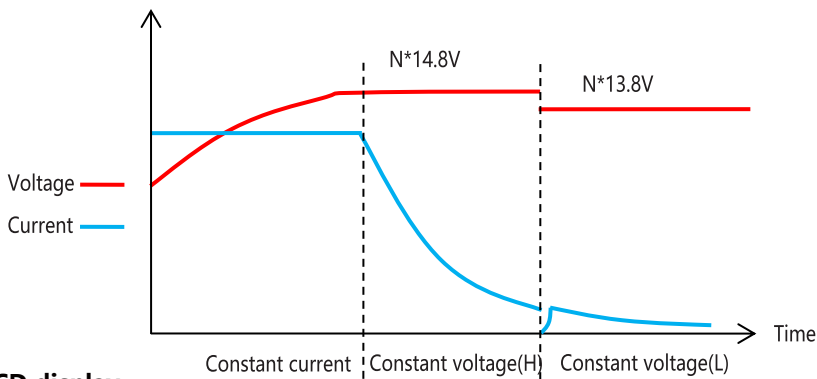

2. LCD display

Current parameters

Setting parameters

Setting Working mode

→

Mechanical specification

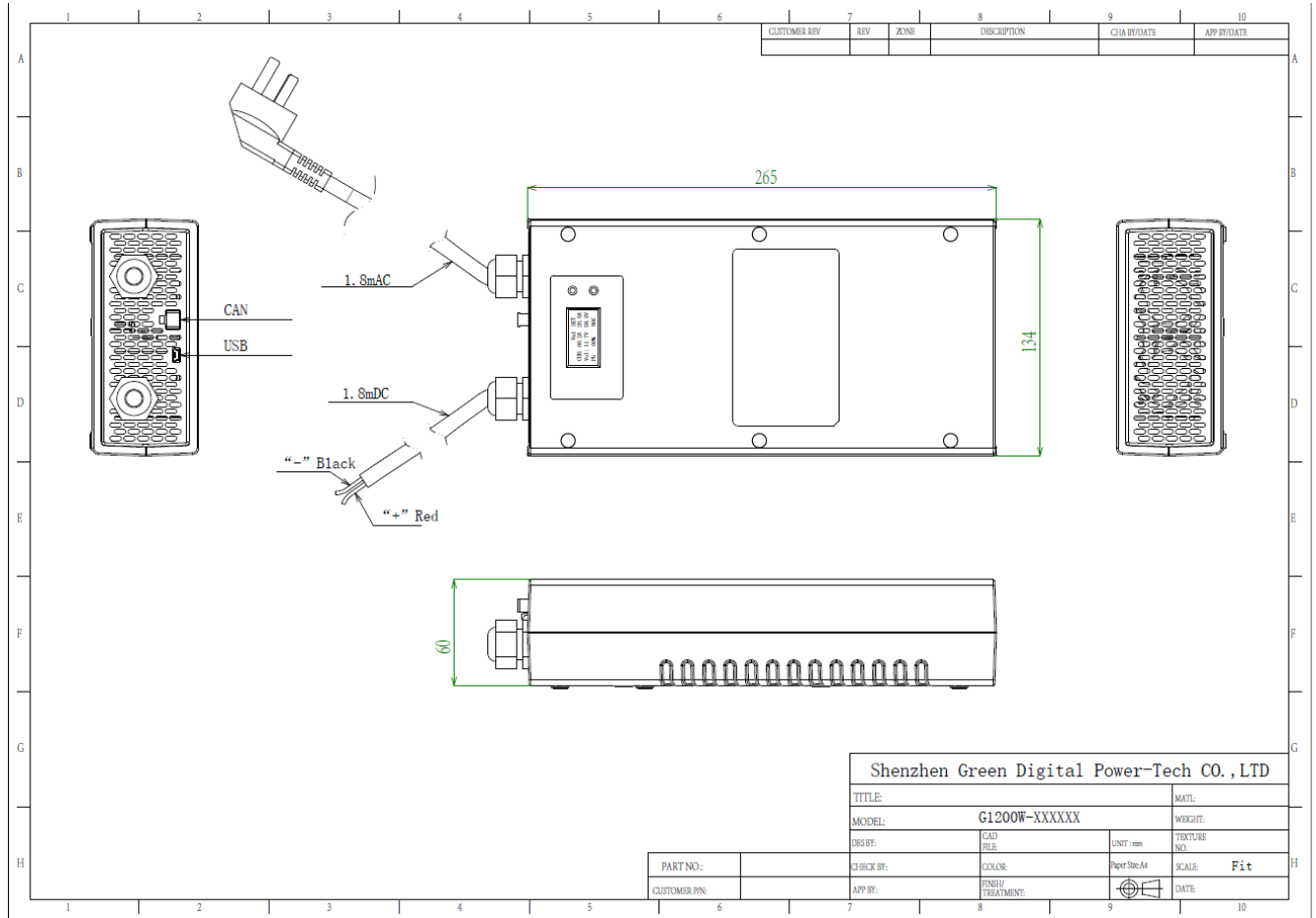

Communication Terminal Pin No. Assignment

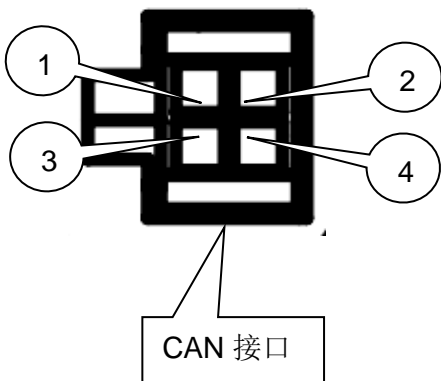

| Pin No. | Assignment |
|---------|------------|
| 1 | CANH |
| 2 | 5V+ |
| 3 | CANL |
| 4 | 5V- |