



■ Features

- Charger for lithium batteries (Li-ion, LiFePO4 and lithium manganese) and Lead-Acid batteries
- Built- in 4 stage charging curve (For Lithium batteries) and 4 stage charging curve (For Lead-Acid batteries)
- Universal AC input / Full range (90-264V~)
- Built- in active PFC function
- Protection: Short circuit / Over voltage / Over temperature / Battery over voltage / Battery reverse polarity protection
- 2 years warranty

■ Applications

- Radio system backup solution
- Electric scooter charger
- Surveillance system
- Electric motorcycle \ Electric sweeper

■ Description

G1200 is a single output 1200W AC/DC desktop type charger with 4 and 3 stage charging curve. In addition to the embedded pre-defined charging curves, the default curve is programmable and thus able to accommodate different types of batteries, such as Lead-acid batteries (gel, flooded and AGM) and Lithium batteries (Li-ion, LiFePO4 and Lithium manganese). G1200 can be set different charging voltage value, charging current value and charging end current value through USB, according to customer's own requirements. The LCD screen of G1200 can display the voltage, current, capacity, and preset voltage and current.

■ Mode Encoding

G1200-XXXXYY



SPECIFICATION(Li-ion battery charger)

MODEL		G1200-252360	G1200-420280	G1200-546200	G1200-672175	G1200-840140	
OUTPUT	Charge voltage	25.2V±1%	42.0V±1%	54.6V±1%	67.2V±1%	84.0V±1%	
	Charge voltage range	15.0-25.2V	25.0-42.0V	32.5-54.6V	40-67.2V	50.0-84.0V	
	Charge current	36.0A±10%	28.0A±10%	20.0A±10%	17.5A±10%	14.0A±10%	
	Pre-charge current	7.2A±10%	5.6A±10%	4.0A±10%	3.5A±10%	2.8A±10%	
	Charge-end current	≤3.6A ±10%	≤2.8A ±10%	≤2.0A ±10%	≤1.8A ±10%	≤1.4A ±20%	
	Rated power	907W	1176W	1092W	1176W	1176W	
	Recommended battery capacity Note.3	80 - 200Ah	60 - 150Ah	40 - 100Ah	40 - 100Ah	30 - 80Ah	
	Leakage current from battery (Typ.)	≤1mA					
Charge indicator	LCD display	Display voltage,current,capacity					
Communication function	USB / CAN / 485	The battery type (Lead acid, Lithium battery,LiFePO4 battery), charging voltage and charging current can be set by USB interface, Communication with external devices via CAN or RS485.					
INPUT	Rated input voltage	100 - 240VAC 50 / 60Hz					
	Input voltage range Note.4	90 - 264VAC					
	Power factor (Typ.)	PF>0.96 @Full load					
	Input current (Typ.)	13A@100VAC					
	Inrush current (Typ.)	Cold start 75A @230VAC					
	Standby input power	< 4W					
	Efficiency (Typ.)	92%	92%	92%	92%	93%	
PROTECTION	Short circuit Note.5	Protection type : Shut down output					
	Over voltage	>4.35V*N					
	Reverse polarity	By internal relay					
	Over temperature	Shut down output, recovers automatically after temperature goes down					
ENVIRONMENT	Working temperature	-10 - +40°C (Refer to " Derating Curve")					
	Working humidity	0 - 90% RH					
	Storage temperature, humidity	-40 - +70°C, 0 - 95% RH					
	Cooling	Fan convection					
	Vibration resistance	10 - 50Hz, 2G 10min. 1cycle, 60min. each along X, Y, Z axes					
Safety & EMC (Note 6)	Max. temperature rise	< 40°C on casing					
	Hi-Pot Insulation	i/p to o/p: 3000V (1 min)					
	Safety standards	IEC60950.1					
	EMC Emission	Parameter	standard			Test Level I Note	
		Conducted	EN55032 FCCPART15			Class B	
		Radiated	EN55032 FCCPART15			Class B	
		Harmonic Current	EN61000-3-2			
Voltage Flicker	EN61000-3-3					
EMC IMMUNITY	EN61000-4-2, EN61000-4-3, EN61000-4-4, EN61000-4-5, EN61000-4-6, EN61000-4-8, EN61000-4-11						
OTHERS	MTBF	30000H					
	Dimension	265*134*60mm (L*W*H)					
	Weight	2300g					
NOTE	<p>1. Modification for charger specification may be required for different battery specification. Please contact battery vendor and Green digital power for details.</p> <p>2. All parameters NOT specially mentioned are measured at 230VAC input, rated load and 25°C of ambient temperature.</p> <p>3. This is Green suggested range. Please consult your battery manufacturer for their suggestions about maximum charging current limitation.</p> <p>4. Derating may be needed under low input voltages. Please check the derating curve for more details.</p> <p>5. This protection mechanism is specified for the case the short circuit occurs after the charger is turned on.</p> <p>6. The battery charger is considered as an independent unit, but the final equipment still need to re-confirm that the whole system complies with the EMC directives. For guidance on how to perform these EMC tests, please refer to "EM I testing of component power supplies."</p>						

■ **Block Diagram**

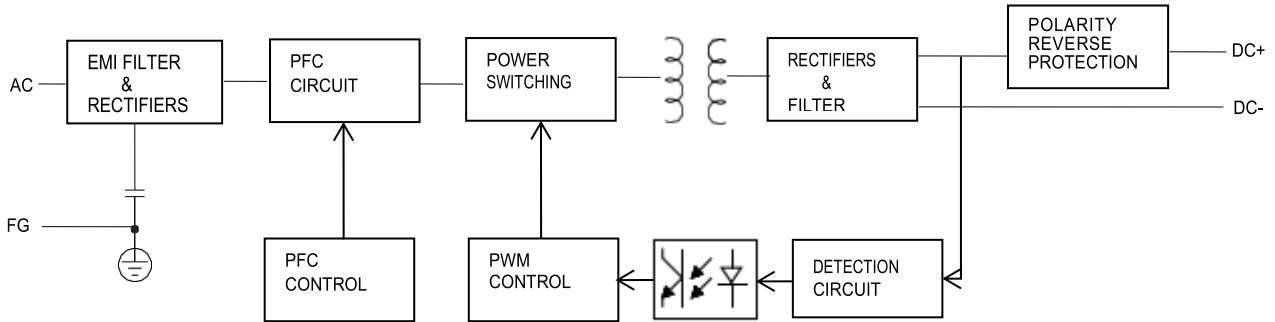

■ **Derating Curve**

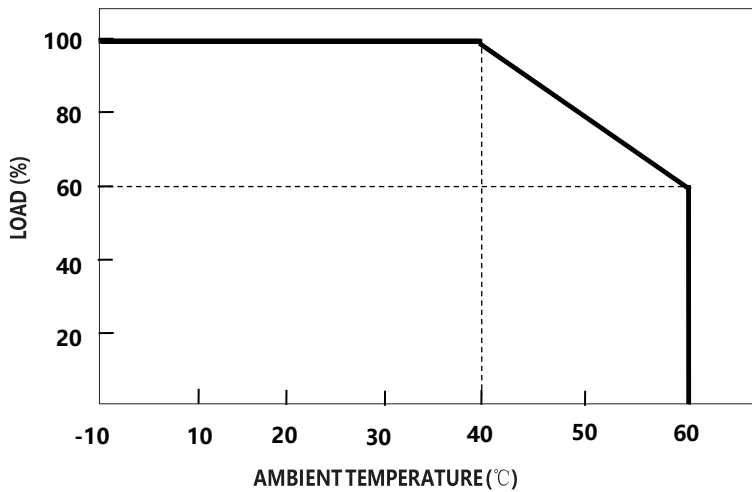

■ **static Characteristics**

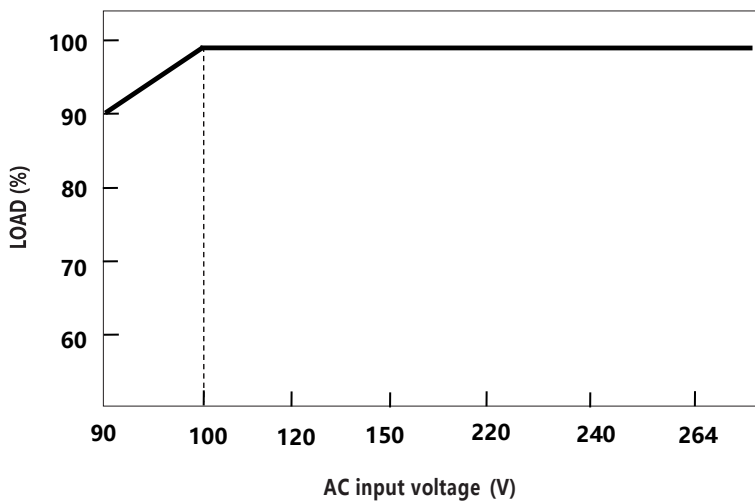

■ **Function Manual**

1. Charging Curve

◎ 4 stage charging curve(Li-ion battery charger)

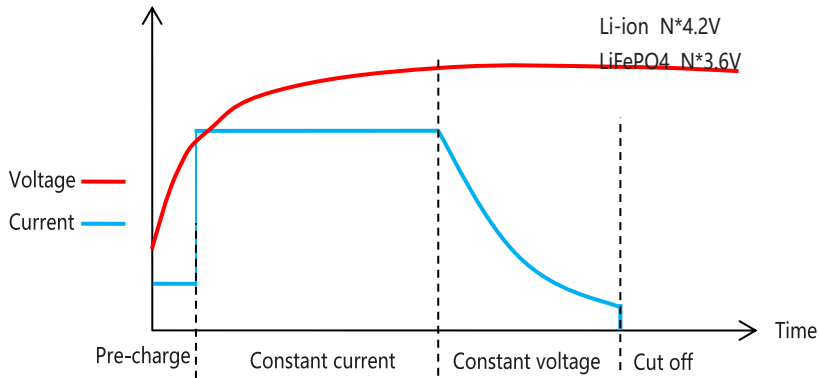

◎ 3 stage charging curve(Lead-Acid battery charger)

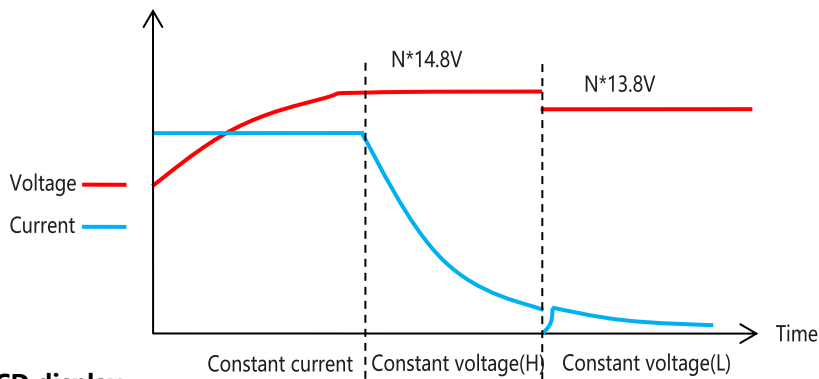

2. LCD display

Current parameters

Setting parameters

Setting Working mode

POWER ▾
 POWER
 LI-ION
 Lead-Acid
 LiFePo4

Mechanical specification

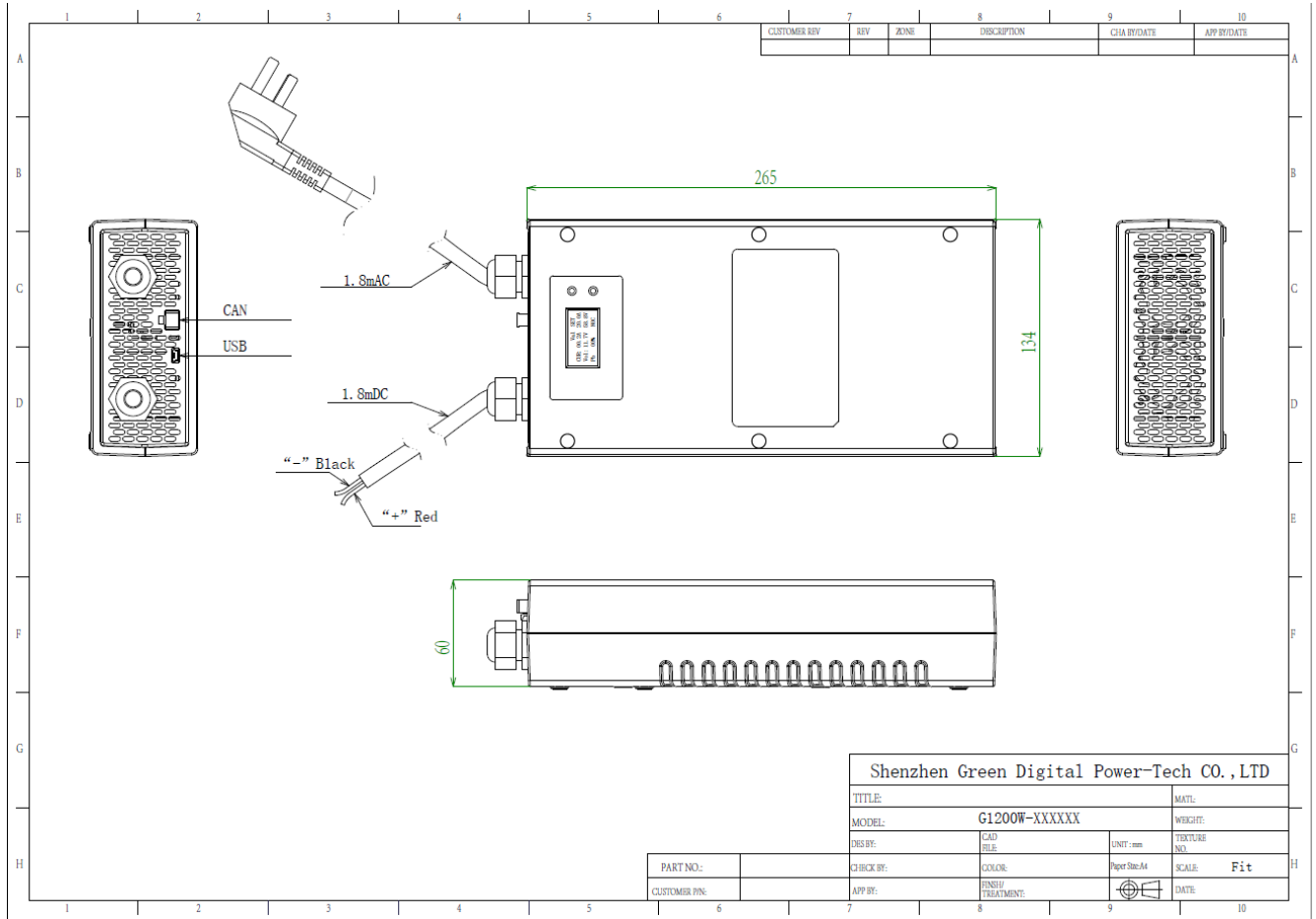

Communication Terminal Pin No. Assignment

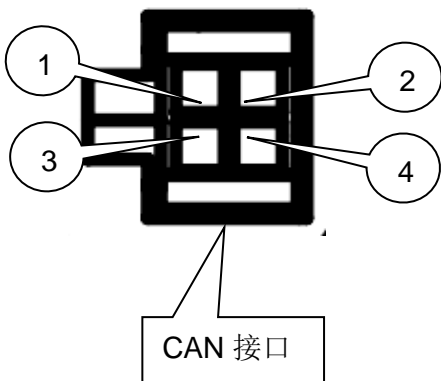

Pin No.	Assignment
1	CANH
2	5V+
3	CANL
4	5V-