

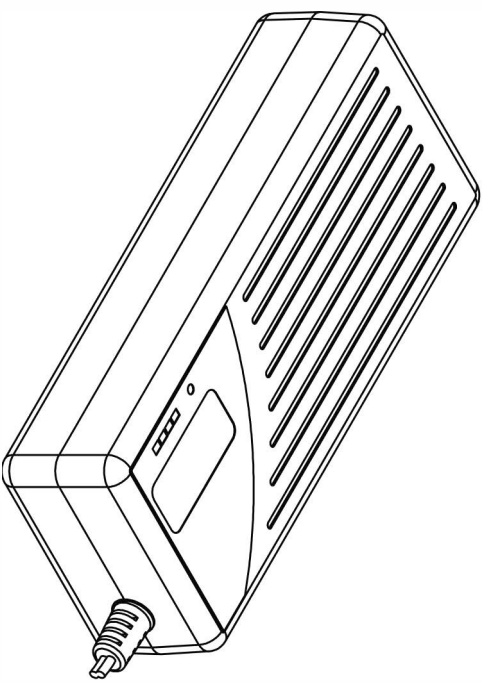

G100-36A (41.4V 1.8A) Pb-Acid Battery Charger		
Item	Specification	Remark
1.Input		
Rating input voltage	100~240Vac 50/60Hz	
Input voltage range	90~264Vac	
Rating input current	1.5Arms	Input:100V Output:Full load
Max input power	100W	Input:100V Output:Full load
2.Output		
No load output voltage	DC44.1V	
Output voltage range	DC30.0~44.1V	
Suit with battery type	36V Pb-Acid battery	
Charging current	1.8A ±10%	
Charging voltage	DC44.1V ±0.9V	
Floating charge voltage	DC39.6V-41.4V	
Charge-end current	≤0.3A ±0.1A	
Timer	10hours	
Max output power	79.38W	
Ripple voltage	≤414mV	Full load
Power LED	Red	Power on
Charging LED	All off	No battery
	All on	Full charge
	All flash	Error
	Flashing one by one	Charging
Shorted	Yes	
Reversed	Yes	
Efficiency	≥87%	Full load @220V
3.Environment		
Operate temperature	-10 ~ +40°C	
Operate humidity	< +90%	Relative humidity
Storage temperature	-40 ~ +70°C	
Storage humidity	0 ~ +95%	Relative humidity
Cooling	Natural	
Vibration resistance	5MM/50HZ/600S	Non-operating condition
Impact resistance	1 meter drop test 3 times	Non-operating condition
4.Mechanical		
Weight	400g	
Size	170X70X41MM	Casing only
Connector	Refer to order	
5.Safety		
Max. temperature rise	< 40°C on casing	
Safety approval	CE/cTUVus/CCC/PSE	
MTBF	30000H	
ESD	8.0KV	
Hi-Pot Insulation	i/p to o/p: 3000V (1 min)	

CUSTOMER REV	REV	ZONE	DESCRIPTION	CHA BY/DATE	APP BY/DATE

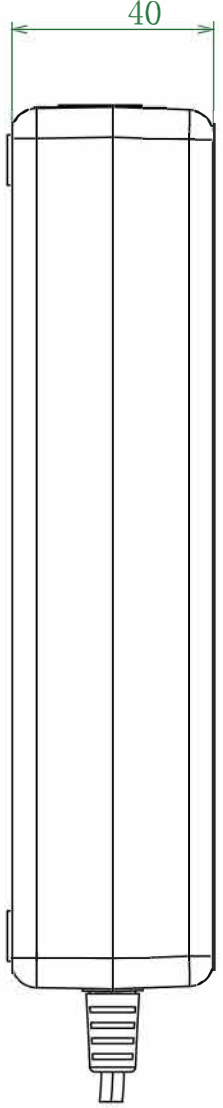
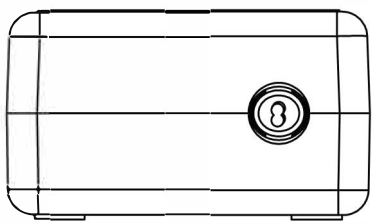
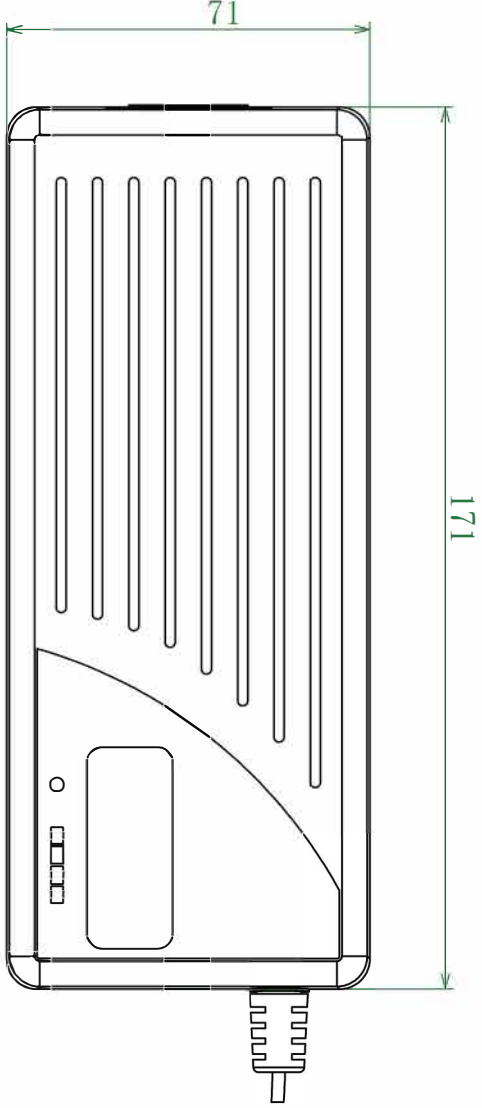

Shenzhen Green Digital Power-Tech CO., LTD

TITLE: G100W

MODEL: MATE: WEIGHT:

DES BY: CAD FILE: UNIT: mm TEXTURE NO

CHECK BY: COLOR: Paper Size: A4 SCALE: Ft

APP BY: FINISH/TREATMENT: DATE:

PART NO.:
CUSTOMER P/N:

