

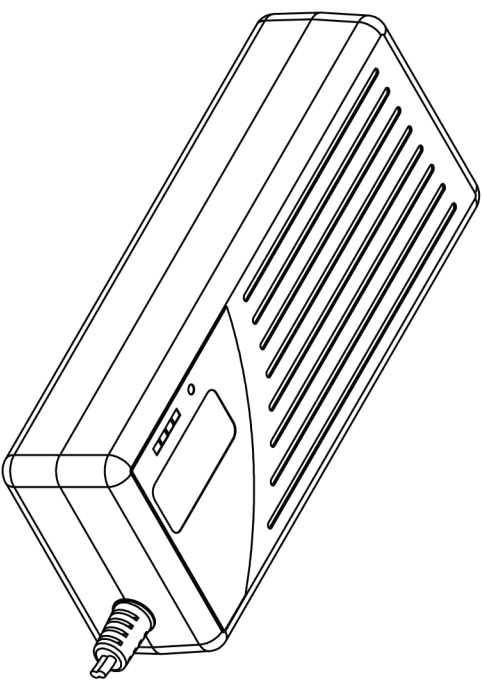

G100-12L (16.8V 4.5A) 4S Li-ion Battery Charger		
项目 Item	规格 Specification	备注 Remark
1.输入特性 Input		
额定输入电压 Rating input voltage	100~240Vac 50/60Hz	
输入电压范围 Input voltage range	90~264Vac	
额定输入电流 Rating input current	1.5Arms	Input:100V Output:Full load
最大输入功率 Max input power	100W	Input:100V Output:Full load
2.输出特性 Output		
空载输出电压 No load output voltage	DC16.8V	
输出电压范围 Output voltage range	DC10.0~16.8V	
适用电池 Suit with battery type	4S Li-ion battery	
恒定电流 Charging current	4.5A ±10%	
恒定电压 Charging voltage	DC16.8V ±0.2V	
预充电流 Pre-charge	0.8±0.2A	电压≤12.0V预充
充电结束电流 Charge-end current	≤0.4A ±0.1A	
定时器 Timer	-	
最大输出功率 Max output power	75.6W	
纹波电压 Ripple voltage	≤168mV	满载 Full load
电源指示灯 Power LED	红色 Red	接通电源 Power on
电量指示灯 Charging LED	不亮 All off	未接电池 No battery
	全亮 All on	充电完成 Full charge
	全闪 All flash	故障 Error
	轮流亮 Flashing one by one	充电中 Charging
输出短路保护 Shorted	有Yes	
输出反接保护 Reversed	有Yes	
效率 Efficiency	≥85%	满载 Full load @220V
3.环境要求 Environment		
工作温度 Operate temperature	-10 ~ +40°C	
工作湿度 Operate humidity	< +90%	相对湿度 Relative humidity
存储温度 Storage temperature	-40 ~ +70°C	
存储湿度 Storage humidity	0 ~ +95%	相对湿度 Relative humidity
冷却方式 Cooling	自然冷却 Natural	
抗振动 Vibration resistance	5MM/50HZ/600S	非运行状况 Non-operating condition
抗冲击 Impact resistance	1 meter drop test 3 times	非运行状况 Non-operating condition
4.结构 Mechanical		
重量 Weight	400g	
尺寸 Size	170X70X41MM	外壳尺寸Casing only
接线端子 Connector	按客户要求制定 Refer to order	
5.安全特性 Safety		
最大温升 Max. temperature rise	< 40°C on casing	
安全认证 Safety approval	CE/UL/SAA/FCC/CCC	
平均无故障时间 MTBF	30000H	
静电等级 ESD	8.0KV	
隔离耐电压 Hi-Pot Insulation	i/p to o/p: 3000V (1 min)	

CUSTOMER REV	REV	ZONE	DESCRIPTION	CHA BY/DATE	APP BY/DATE

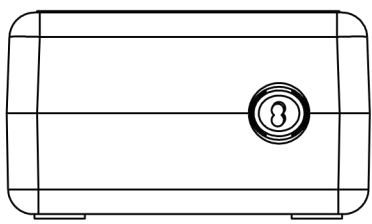
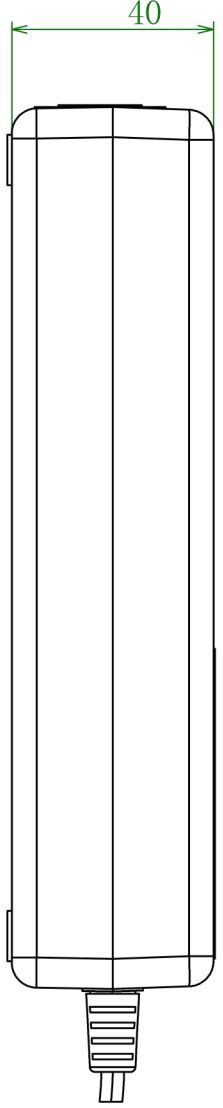
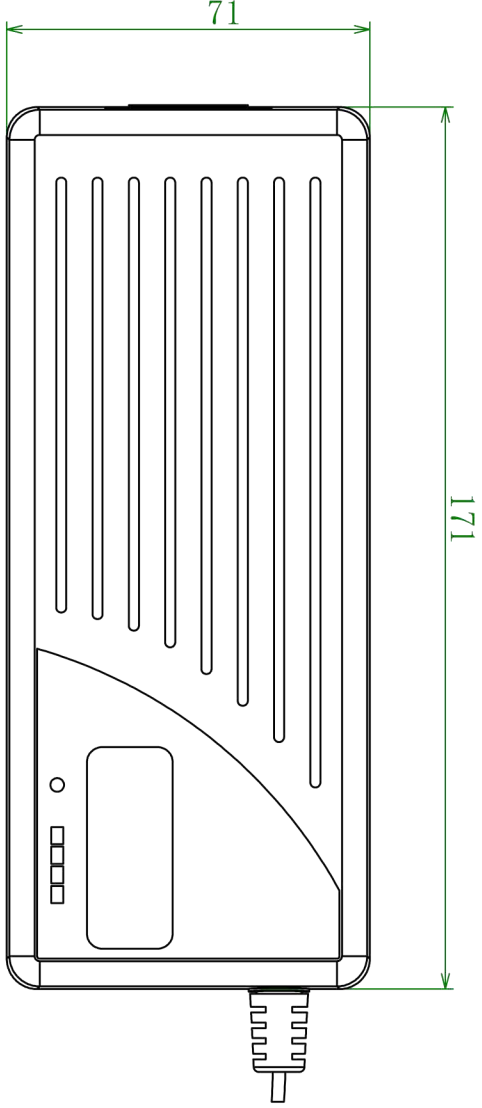

深圳市谷润数字电源有限公司

TITLE: G100W

MODEL: MATL: WEIGHT:

DES BY: CAD FILE: UNIT: mm TEXTURE NO.

CHECK BY: COLOR: Paper Size:A4 SCALE: **Fit**

APP BY: FINISH/TREATMENT: DATE:

PART NO.:	CUSTOMER P/N: